

P121

Nöding

Messtechnik



Datasheet Pressure Transmitter P121

PERFORMANCE FEATURES

- Dry capacitive ceramic sensor
- Smallest measuring range: 0...40 mbar
- Largest measuring range: 0...250 bar
- Negative pressure measuring range: up to -1 bar
- Accuracy $\leq 0,2\%$
- High overload capability
- Compact and rugged design
- Optionally in plastic PP or PVDF
- Analog output: 4...20 mA, 2-wires
0...10 V, 3-wires
- DNV certified
- Ex II 1G Ex ia IIC T4 Ga 
I M2 Ex ia I Mb

AREAS OF APPLICATION

- Gaseous media
- Potentially explosive areas
- Liquid media
- Abrasive media
- Aggressive media
- Maritime applications

The P121 model was designed for use in harsh industrial environments. It features a high-resolution ceramic sensor, ATEX certification, and numerous configuration options. DNV certified, the sensor also finds use in marine applications and provides excellent mechanical resistance. The ceramic sensor element is resistant to aggressive and abrasive media. The capacitive measuring principle enables a very accurate and long-term stable measurement, even at lowest pressures and high overload resistance. Its compact housing is made of high-quality stainless steel 1.4404 and is therefore suitable for almost all media. For highly aggressive chemicals, variants in PP or PVDF are recommended. Our modular design concept provides a wide variety of products. Feel free to contact us if you need a customization that is not listed in this datasheet.

TECHNICAL DATA

Measuring range	
Pressure range	See table "Measuring ranges" others on request
Output	
Analog output	4...20 mA 2-wires 0...10 V 3-wires
Power supply	
20 mA output	9...30 V DC
10 V output	15...30 V DC
EX Version	12...30 V DC
Signal characteristics	
Accuracy	$\leq \pm 0,2 \% \text{ FS @ } 25^\circ\text{C}$ $\leq \pm 0,5 \% \text{ FS @ } 25^\circ\text{C}$ at pressure range $\leq 60 \text{ mbar}$ $\leq \pm 0,5 \% \text{ FS @ } 25^\circ\text{C}$ at pressure range $\geq 100 \text{ bar}$
Long term stability	$\leq \pm 0,15 \% \text{ FS/Year}$
Response time	200 ms - others on request
Switch-on time	< 1 s
Temperature coefficient	
Zero	$\leq \pm 0,015 \% \text{ FS/Kelvin}$
Span	$\leq \pm 0,01 \% \text{ FS/Kelvin}$
Temperature ranges	
Medium temperature	-40...100 °C (125 °C < 0,5 h) -20...80 °C with EX ia IIC T4
Surrounding temperature	-25...80 °C -20...80 °C with EX ia IIC T4
Storage temperature	-40...85 °C
Electrical protections	
Short-circuit resistance	Permanent
Reverse polarity protection	Protection against reverse polarity, but no function
Electromagnetic compatibility	Interference emissions and immunity acc. to EN 61326
Mechanical resistance	
Vibration	4g with 3-axis resonance frequency according to DIN EN 60068-2-6:2008
Wetted materials	
Process connection	Stainless steel 1.4404, PP or PVDF
Sensor	Ceramic Al_2O_3 - FDA
Sensor seal	FPM (Viton), NBR, EPDM, FFKM (Chemraz/Kalrez)
Surroundings	
Protection type	see "Electrical connection" in Ordering Code
Exemplary weight	
P121-400-G11 (figure p. 1)	Approx. 260 g

ELECTRICAL CONNECTION

Connector
EN 175301-803A

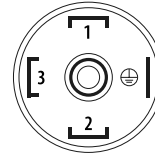

4...20 mA 2-wires
PIN 1: Signal +
PIN 2: Signal -

0...10 V 3-wires
PIN 1: in +
PIN 2: in -
PIN 3: out +

Quickon-Connector

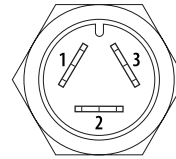

4...20 mA 2-wires
PIN 1: Signal +
PIN 2: Signal -

0...10 V 3-wires
PIN 1: in +
PIN 2: in -
PIN 3: out +

Cable connection

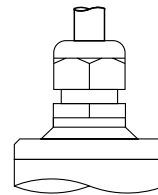

4...20 mA 2-wires
red: Signal +
black: Signal -

0...10 V 3-wires
red: in +
black: in -
white: out +

M12 Connector

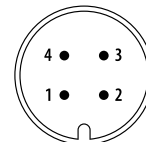

4...20 mA 2-wires
PIN 1: Signal +
PIN 3: Signal -

0...10 V 3-wires
PIN 1: in +
PIN 3: in -
PIN 4: out +

LOAD

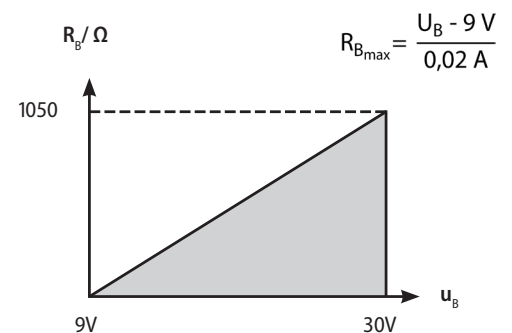

MEASURING RANGE

Measuring ranges	Relative	Absolute	Overload (bar)
0...40 mbar / 0...4 kPa *	A8		-0,3/4
0...50 mbar / 0...5 kPa*	B0		-0,3/4
0...60 mbar / 0...6 kPa*	A9		-0,3/4
0...100 mbar / 0...10 kPa	00		-0,3/4
0...160 mbar / 0...16 kPa	01		-0,6/6
0...200 mbar / 0...20 kPa	B1		-1/6
0...250 mbar / 0...25 kPa	02		-1/6
0...400 mbar / 0...40 kPa	03		-1/6
0...500 mbar / 0...50 kPa	B7		-1/6
0...600 mbar / 0...60 kPa	04	29	-1/6
0...1 bar / 0...100 kPa	05	30	-1/10
0...1,6 bar / 0...160 kPa	06	31	-1/15
0...2 bar / 0...200 kPa	B3	B4	-1/15
0...2,5 bar / 0...250 kPa	07	32	-1/15
0...4 bar / 0...400 kPa	08	33	-1/25
0...5 bar / 0...500 kPa	F1	F2	-1/40
0...6 bar / 0...600 kPa	09	34	-1/40
0...10 bar / 0...1 MPa	10	35	-1/40
0...16 bar / 0...1,6 MPa	11	36	-1/40
0...20 bar / 0...2 MPa	B5	B6	-1/40
0...25 bar / 0...2,5 MPa	12	37	-1/40
0...40 bar / 0...4 MPa***	13	38	-1/60
0...50 bar / 0...5 MPa***	F3	F4	-1/100
0...60 bar / 0...6 MPa***	14	39	-1/100
0...100 bar / 0...10 MPa * / **	15	40	-1/250
0...160 bar / 0...16 MPa * / **	16	41	-1/400
0...250 bar / 0...10 MPa * / **	17	42	-1/600
0,8...1,2 bar / 80...120 kPa		B9	-1/10
-25...25 mbar / -2,5...2,5 kPa*	E6		-0,3/4
-50...50 mbar / -5...5 kPa	C3		-0,3/4
-100...0 mbar / -10...0 kPa	C4		-0,3/4
-100...100 mbar / -10...10 kPa	C5		-1/6
-200...0 mbar / -20...0 kPa	D2		-1/6
-200...200 mbar / -20...20 kPa	D3		-1/6
-1...0 bar / -100...100 kPa	D4		-1/10
-1...1 bar / -100...100 kPa	D6		-1/10
-1...3 bar / -100...300 kPa	D8		-1/25
-1...5 bar / -100...500 kPa	D9		-1/40
-1...9 bar / -100...900 kPa	E1		-1/40
-1...15 bar / -0,1...1,5 MPa	E2		-1/40
-1...19 bar / -0,1...1,9 MPa	E3		-1/40

* Accuracy 0,5%

** Only with process connection 2, 3, G (others on request)

*** not available in PP/PVDF

ORDERING CODE

Output signal

- 1 0...10 V 3-wires
- 4 4...20 mA 2-wires
- H 4...20 mA 2-wires high temperature version -25...120 °C
- EX 4...20 mA 2-wires, II 1G Ex ia IIC T4 Ga
- MX 4...20 mA 2-wires, I M2 Ex ia I Mb

Ranges

Measuring ranges see table

- 99 Non-standard range (on request)

Process connection and material

- D G 1/4 A, DIN EN ISO 1179-2, 1.4404
- 3 G 1/2 B, EN 837-1, 1.4404
- G G 1/2 A a. 11,8 mm drill hole, ISO 228-1, 1.4404
- GL G 1/2 A a. 11,8 mm drill hole, ISO 228-1, 1.4539
- 4 G 1/2 A a. G 1/4 inside, ISO 228-1, 1.4404
- DN 1/4 - 18 NPT, 1.4404
- 2 1/2 - 14 NPT, 1.4404
- GS G 1/2 A, 10 mm borehole, ISO 228-1, PP (no EX possible)
- GP G 1/2 A, 10mm, borehole, ISO 228-1, PVDF (no EX possible)
- 9 Others (on request)

Sensor seal

- 1 FPM (Viton), standard
- 2 NBR (Perbuan), max. 80 °C
- 3 EPDM
- 5 FFKM (Chemraz / Kalrez)
- 9 Others (on request)

Electrical connection

- 1 Connector EN 175301-803A IP 65
- 4 Connector EN 175301-803A IP 65, potted electronics
- A Connector M12x1 IP 65
- B Connector M12x1 IP 65, potted electronics
- F Quickon-Connector IP 65
- G Quickon-Connector IP 65, potted electronics
- 0 5 m cable, IP67
- 5 5 m cable, potted electronics, IP67
- 6 2 m cable, IP67
- 7 2 m cable, potted electronics, IP67
- 9 Others (on request)

Options (Multiple selections possible)

- R Ceramic sensor 99,9%
- T Minimized case volume
- D DNV certified¹
- 67 Protection Type IP 67
- 01 0,1 % Accuracy²
- X Oxygen applications

P121- [] - [] [] [] [] ...

¹ If the option "DNV certified" is selected, an FEP cable is used for the cable outlet

² Only with relative pressure

DIMENSIONS

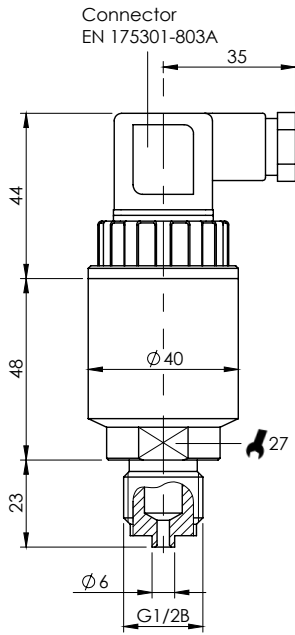

PROCESS CONNECTION ■ TYPE 3

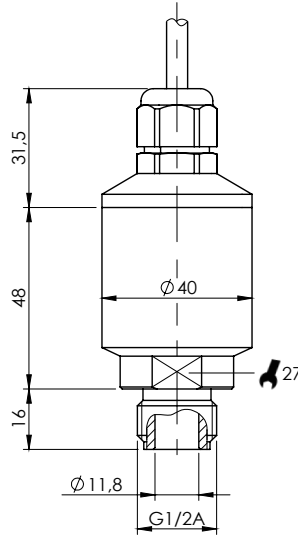

■ TYPE G

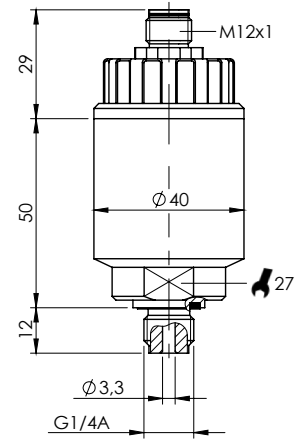

■ TYPE D

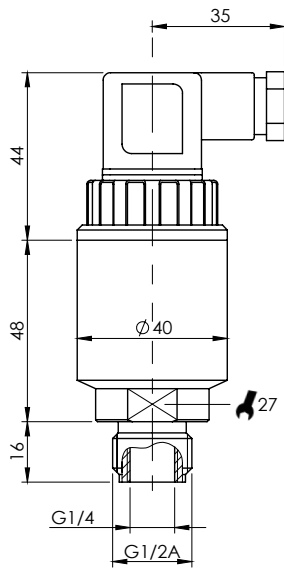

PROCESS CONNECTION ■ TYPE 4

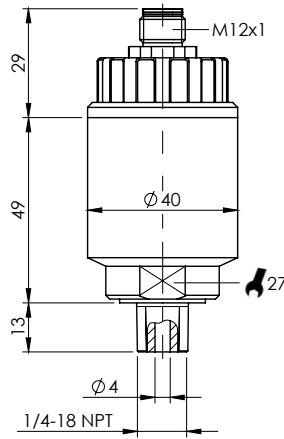

■ TYPE DN

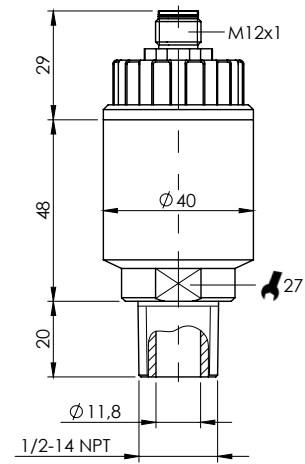

■ TYPE 2

■ DIMENSIONS

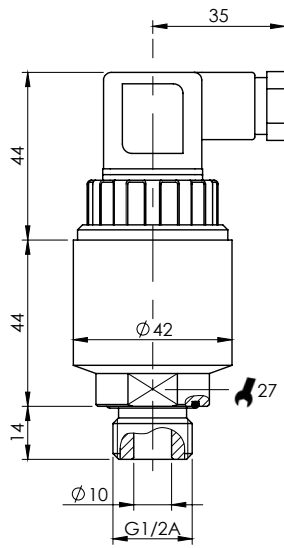

PROCESS CONNECTION ■ TYPE G2/GP